

A wide-angle photograph of a modern interior space. A long, low wooden cabinet with a blue cushioned top runs along a large window. The window is covered with light-colored roller blinds. The room has a wooden floor, track lighting on the ceiling, and a bookshelf on the right. A potted plant is visible in the foreground on the right.

**MANUAL
INSTALLATION**

A closer view of the roller blinds installed on the window. The blinds are light-colored and partially rolled up, showing the window frame and the view outside. The wooden cabinet and blue cushion are visible in the foreground.

Roller blind

GENERAL SAFETY INFORMATION

This manual lists the instructions for proper installation, use and maintenance of the roller blind, drawn up to avoid damage to persons or property and for proper use and conservation of the product.

It is advisable to keep this manual and keep it always available for further consultation until the tent is disposed of.

The manual consists of this booklet, any photographic assembly instructions and any engine instructions attached to the product.

THE MANUAL IS AIMED AT THE INSTALLER, MAINTAINER AND END USER.

⚠ ATTENTION!

When freeing the curtain from the packaging do not use sharp tools such as scissors or cutters as you could cut chains and fabrics compromising the functionality of the tent.

Installation must be performed exclusively by specialized personnel and must be carried out in compliance with current regulations on safety and prevention from accidents at work.

Check that the ladders, scaffolding, protective devices and tools that are used are up to standard and in good condition.

In order to correct installation, use the material supplied with the product that are according to the size and model of the curtain; It is also necessary to use screws and dowels adapted to the state and type of structure/mute on which the roller blind is installed.

They can not be mounted inclined.

DIFFERENT INSTALLATION SOLUTIONS

- Ceiling mounted (Fig.1)
- Wall mounted (Fig.2)
- Wall-mounted with shelves (Fig.3)

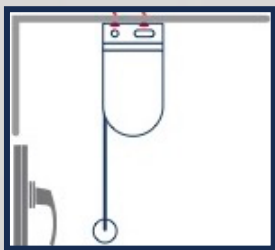

Fig. 1

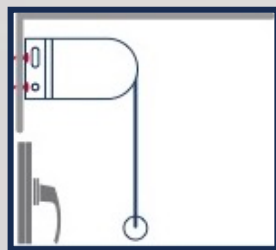

Fig. 2

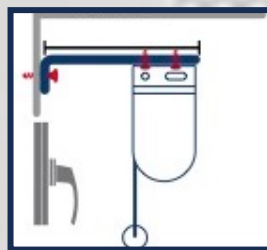
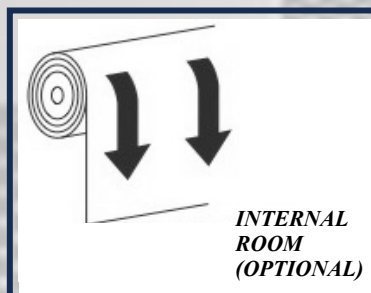
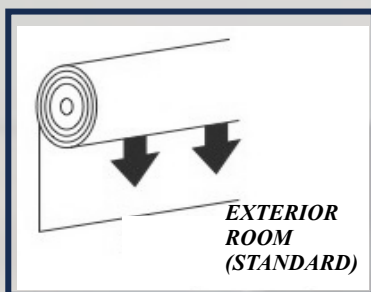

Fig. 3



The descent of the Standard roller blind is "external" towards the wall of the room; You can choose the descent inwards to have more space between the wall and the fabric so that protruding handles are not touched.

HOW TO MOUNT A ROLLER BLIND

1) MEASURE WIDTH:

If you want to hang the curtain inside the window frame, measure the width of the curtain, including the mounting brackets. Leave an additional 5mm of space on each side of the frame, so you can easily mount the brackets.

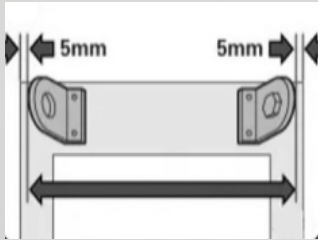

2) DECIDE WHICH SIDE TO MOUNT THE CHAIN/WINCH / MOTOR:

Decide where you want to mount the chain/winch / roller curtain motor, on the left or right side. Once you have marked the position, fix the brackets inside or on the window frame. The bracket with a protruding pin indicates the side with the chain/motor mechanism.

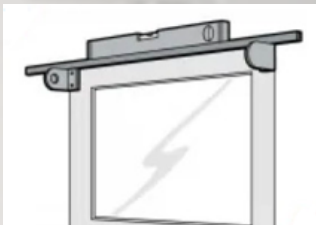

3) MOUNTING THE BRACKETS ON THE WINDOW FRAME OR WALL:

Decide on the location of the first bracket and mark the holes to drill. Then mount the first bracket and tighten the screws slightly, adjust the roller with a level, so that it is horizontal. Then mark the holes to drill for the second bracket.

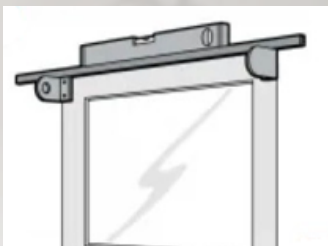

4) MOUNTING CEILING BRACKETS:

Measure the width of the roller blind and subtract the measure of the width of the window and finally divide by two.

Leave the same measure laterally to center the curtain.

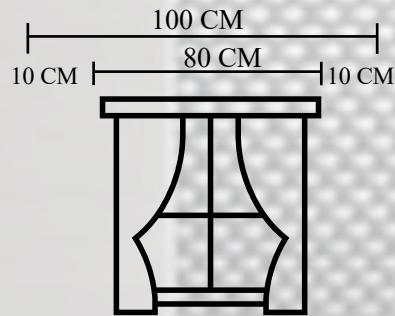
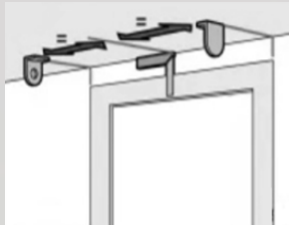

5) HANG THE CURTAIN:

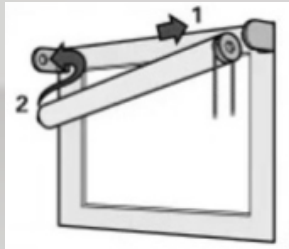

First insert the roller into the bracket with the chain mechanism / winch / motor and then into the other.

IN CASE OF MOTORIZED TENT

- The electrical connection must be carried out exclusively by qualified technicians as reported in the motor card attached to the product.
- Check that the electrical system of the room complies with current regulations and that the electrical circuit has the necessary degree of protection.
- Uphill and downhill limit switches are already adjusted, if you want to change the adjustments, follow the engine instructions.
- For any information on the installation, use and maintenance of the engine, refer to the manufacturer's instructions attached to the product.

CLEANING AND MAINTENANCE

- Periodically remove dust from the tent using soft dry cloths or slightly moistened with water or neutral cleaning products, taking care to dry thoroughly.
- Do not use aggressive or abrasive detergents.
- Do not remove any part of the tent or internal components, nor intervene on it, on moving parts, on electrical parts.
- Any intervention on electrical parts must be performed by qualified personnel.

ENVIRONMENTAL IMPACT AND DISPOSAL

- The removal of the curtain of its seat must be carried out by qualified personnel and observing all the instructions safety warnings of the installation.
- Operations must be carried out with the curtain closed.

Mission and values



Innovation

Constantly investing in innovative technologies, automation and home automation in order to create products that comply with and in line with the trends of the reference market and customer convenience.



Sustainability

Attention to a sustainable production development in accordance with international objectives (Agenda 2030) and environmental standards as well as compliance with current safety regulations.



Customer Service & Support

Maximum attention to the customer that manifests itself both in compliance with delivery times in addition to the obsequious care of every single detail. We can deliver not only products, but also turnkey solutions that include the finished assembly on site.



Personalization

We have a global view of the market and the relevant demands and requirements. We are very flexible and want to be your partner for customized products / solutions, which are one of our strengths.



AGB DESIGN S.r.l.

Via delle Piagge, 1367

Zona Ind. S. Alessio 55100 LUCCA

Ph. +39 0583 330618 Fax +39 0583 330000 e-

mail: info@aqbdesign.it

VAT 02194300469